

moviCompile: An LLVM based compiler for heterogeneous SIMD code generation

Erkan Diken, Roel Jordans, *Martin J. O’Riordan
Eindhoven University of Technology, Eindhoven
() Movidius Ltd., Dublin*

LLVM devroom FOSDEM’15
Brussels, Belgium

February 1, 2015

CONTENT

BACKGROUND

- SIMD

- Heterogeneous SIMD

- SHAVE Vector Processor

CODE GENERATION

- SIMD Code generation for SHAVE

- Contribution

- Adding a new vector type

- Type Legalization

- Common Errors

- Instruction Selection and Lowering

RESULTS

CONCLUSION

SIMD

```
for (i=0; i < N; i++)
  C[i] = A[i] + B[i]
```

scalar unit

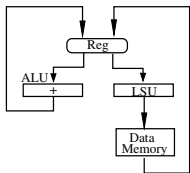

N $\left\{ \begin{array}{l} \text{LSU.LD R1 addr1} \\ \text{LSU.LD R2 addr2} \\ \text{ALU.ADD R3 R1 R2} \\ \text{LSU.ST R3 addr3} \end{array} \right.$

SIMD (vector) unit

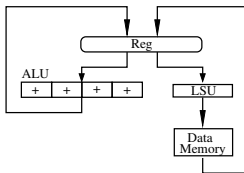

N/4 $\left\{ \begin{array}{l} \text{LSU.LD R1 addr1} \\ \text{LSU.LD R2 addr2} \\ \text{ALU.ADD R3 R1 R2} \\ \text{LSU.ST R3 addr3} \end{array} \right.$

- ▶ Single-instruction multiple-data (SIMD) model of execution
- ▶ The same instruction applies to all processing elements
- ▶ Improves performance and energy efficiency

HETEROGENEOUS SIMD

- ▶ Variable SIMD-width: Intel's SSE/AVX support 128/256/512-bit SIMD, 1024-bit in the future

```
for (i=0; i < N; i++)  
  C[i] = A[i] + B[i]
```

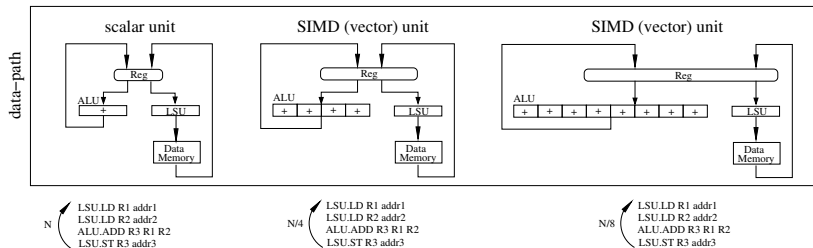

- ▶ **Our focus:** VLIW data-path with multiple native SIMD-widths

SHAVE VECTOR PROCESSOR

The SHAVE (Streaming Hybrid Architecture Vector Engine) VLIW vector processor

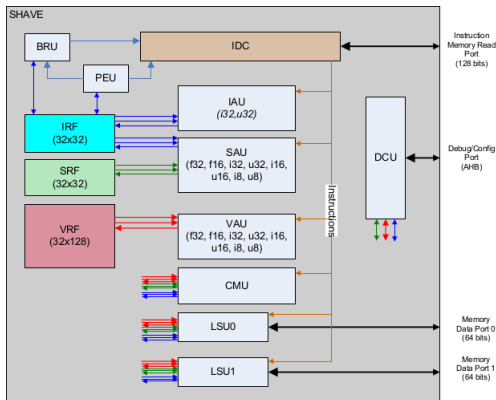

SIMD CODE GENERATION FOR SHAVE

- ▶ VAU is designed to support 128-bit vector arithmetic of 8/16/32-bit integer and 16/32-bit floating-point types.
- ▶ Instruction set (ISA) supports a range of precision
- ▶ Current compiler supports 128-bit and 64-bit SIMD code generation.
- ▶ 128-bit legal vector types: 16 x i8, 8 x i16, 4 x i32, 8 x f16, 4 x f32
- ▶ 64-bit legal vector types: 8 x i8, 4 x i16, 4 x f16
- ▶ What about 32-bit vector types: 4 x i8, 2 x i16, 2 x f16 (short vectors) ?

CONTRIBUTION

- ▶ Short vectors are promoted to longer types before vector computation on VAU
- ▶ SAU supports 32-bit vector arithmetic of 8/16-bit integer and 16-bit floating-point types.
- ▶ **Contribution:** Adding compiler support for 32-bit SIMD code generation.
- ▶ SIMD code for short vector types (e.g. 4 x i8, 2 x i16, 2 x f16) that can be executed on 32-bit SAU next to 128/64-bit VAU instruction

LLVM CODE GENERATION FLOW

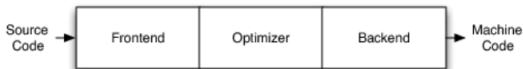

(*) Tutorial: Creating an LLVM Backend for the Cpu0 Architecture
(<http://jonathan2251.github.io/lbd/llvmstructure.html>)

LLVM CODE GENERATION FLOW

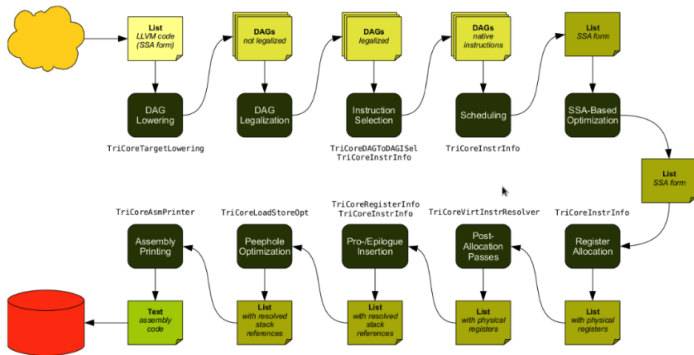

- ▶ Already in place: data-layout, triple, target registration, register set and classes, instruction set definitions
- ▶ Main focus on TableGen, type legalization and lowering for instruction selection

(*) Tutorial: Creating an LLVM Backend for the Cpu0 Architecture
(<http://jonathan2251.github.io/lhd/llvmstructure.html>)

Listing 1: 4 x i8

```
define i32 @main() {
entry:

; memory allocation on run-time stack
%xptra = alloca <4 x i8>
%yptra = alloca <4 x i8>
%zptr = alloca <4 x i8>

; load the vectors
%x = load <4 x i8>* %xptra
%y = load <4 x i8>* %yptra

; add the vectors
%z = add <4 x i8> %x, %y

; store the result vector back to stack
store <4 x i8> %z, <4 x i8>* %zptr

ret i32 0
}
```

Listing 2: Assembly code with long vector operations

```
main:
IAU.SUB i19 i19 16
LSU1.LDO32 i9 i19 8
LSU1.LDO32 i10 i19 12
NOP 4
CMU.CPIV.x32 v14.0 i9
CMU.CPIV.x32 v15.0 i10
CMU.CPVV.i8.i16 v14 v14
CMU.CPVV.i8.i16 v15 v15
VAU.ADD.i16 v15 v15 v14
NOP
BRU.JMP i30
  || CMU.VSZMBYTE v15 v15 [Z2Z0]
CMU.CPVV.u16.u8s v15 v15
CMU.CPVI.x32 i17 v15.0
IAU.ADD i19 i19 16
  || LSU0.LDIL i18 0
  || LSU1.STO32 i17 i19 4
```

BEFORE YOU START

- ▶ <http://llvm.org/docs/WritingAnLLVMBackend.html>
- ▶ *Building an LLVM Backend* by Fraser Cormack and Pierre-Andre Saulais
- ▶ LLVM build in debug mode
- ▶ `./llc -debug, -print-after-all, -debug-only=shave-lowering`
- ▶ `-view-dag-combine1-dags`: displays the DAG after being built, before the first optimization pass.
- ▶ `-view-legalize-dags`: displays the DAG before legalization.
- ▶ `-view-dag-combine2-dags`: displays the DAG before the second optimization pass.
- ▶ `-view-isel-dags`: displays the DAG before the Select phase.
- ▶ `-view-sched-dags`: displays the DAG before Scheduling.
- ▶ Get ready with your favorite editor (emacs llvm mode)

ADDING A NEW TYPE OF V4I8

Type Legalization: Make v4i8 vector type legal for the target

```
unsigned supportedIntegerVectorTypes[] = {MVT::v16i8, MVT::v8i16, MVT::↔  
v4i32, MVT::v4i16, MVT::v8i8, MVT::v4i8};
```

Specify which types are supported:

Listing 3: SHAVERegisterInfo.td

```
def IRF32: RegisterClass<"SHAVE", [i32, v4i8], 32,  
    (add,  
     I10, I9 ... //register list  
    )>;
```

Register class association: register class is available for the value type

Listing 4: SHAVELowering.cpp

```
addRegisterClass(MVT::v4i8, &SHAVE::IRF32RegClass)
```

FIRST BUILD, FIRST ERROR

tblgen: error: **Could not infer all types in pattern!**

```
class IAU_RROpC<SDNode opc, RegisterClass regVT, string asmstr> :  
  SHAVE_IAUInstr<(outs regVT:$dst), (ins regVT:$src),  
    !strconcat(asmstr, " $dst $src"),  
    [(set regVT:$dst, (opc regVT:$src))]>;
```

Well-typed class:

```
class IAU_RROpC<SDNode opc, RegisterClass regVT, string asmstr> :  
  SHAVE_IAUInstr<(outs regVT:$dst), (ins regVT:$src),  
    !strconcat(asmstr, " $dst $src"),  
    [(set (i32 regVT:$dst), (opc (i32 regVT:$src)))]>;
```

FIRST TEST, SECOND ERROR: **CANNOT SELECT**

- ▶ v4i8 is legal type now (Type Legalization ✓)
- ▶ Pattern matching and instruction selection
- ▶ Which operations are supported for supported ValueTypes ?
 - ▶ Legal: The target natively supports this operation.
 - ▶ Promote: This operation should be executed in a larger type.
 - ▶ Expand: Try to expand this to other operations.
 - ▶ Custom: Use the LowerOperation hook to implement custom lowering.
- ▶ Start with adding patterns in .td files for legal operations

```
class SAU_RRROpC<SDNode opc, RegisterClass regVT, ValueType vt, string←  
asmstr> :  
    SHAVE_SAUInstr<(outs regVT:$dst), (ins regVT:$src1, regVT:$src2),  
        !strconcat(asmstr, " $dst $src1 $src2"),  
        [(set (vt regVT:$dst), (opc regVT:$src1, regVT:$src2))]>;
```

```
multiclass SAU_IRF_8_16_32_RRROp<SDNode opc, string asmstr>  
{  
    //scalar types  
    def _i32 : SAU_RRROpC<opc, IRF32, i32, !strconcat(asmstr, ".i32")>;  
  
    // Vector types  
    def _v4i8 : SAU_RRROpC<opc, IRF32, v4i8, !strconcat(asmstr, ".i8")>;  
}
```

```
defm SAU_ADD : SAU_IRF_8_16_32_RRROp<add, ".ADD">;
```

Assembly string:

```
SAU.ADD.i8 $dst $src1 $src2
```

CUSTOM LOWERING

Add callback for operations that are NOT supported by the target:

```
setOperationAction(ISD::EXTRACT_SUBVECTOR, MVT::v4i8, Custom);
```

```
SDValue LowerOperation(SDValue Op, SelectionDAG &DAG) const;
{
    switch (op.getOpcode ())
    {
        ...
        case ISD::EXTRACT_SUBVECTOR :
            return SHAVELowerEXTRACT_SUBVECTOR (op, DAG);
        ...
    }
}
```

```
SDValue SHAVELowering::SHAVELowerEXTRACT_SUBVECTOR(SDValue op, ←
    SelectionDAG &DAG) const
{
    SDNode *Node = op.getNode();
    SDLoc dl = SDLoc(op);
    SmallVector<SDValue, 8> Ops;

    SDValue SubOp = Node->getOperand(0);
    EVT VVT = SubOp.getNode()->getValueType(0);
    EVT EltVT = VVT.getVectorElementType();
    unsigned idx = Node->getConstantOperandVal(1);

    EVT VecVT = op.getValueType();
    unsigned NumExtElements = VecVT.getVectorNumElements();

    for (unsigned i=0; i < NumExtElements; i++) {
        Ops.push_back(DAG.getNode(ISD::EXTRACT_VECTOR_ELT, dl, EltVT, SubOp←
            , DAG.getConstant(idx+i, MVT::i32, false)));
    }

    return DAG.getNode(ISD::BUILD_VECTOR, dl, op.getValueType(), Ops);
}
```

Listing 5: Assembly code with short vector operations

```
main:
IAU.SUB i19 i19 16
LSU1.LDO32 i10 i19 12
  || LSU0.LDO32 i9 i19 8
NOP 2
BRU.JMP i30
NOP 2
SAU.ADD.i8 i10 i10 i9
NOP
IAU.ADD i19 i19 16
  || LSU0.LDIL i18 0
  || LSU1.STO32 i10 i19 4
```

Listing 6: IR code with two different vector types

```
define <4 x i8> @main(<4 x i8> %a, <4 x i8> %b,  
                    <8 x i8> %x, <8 x i8> %y,  
                    <8 x i8>* %zptr){  
entry:  
    %c = add <4 x i8> %a, %b  
    %z = add <8 x i8> %x, %y  
    store <8 x i8> %z, <8 x i8>* %zptr  
    ret <4 x i8> %c  
}
```

Listing 7: Heterogeneous SIMD assembly code

```
main:
    BRU.JMP i30
    CMU.CPVI.x32 i9 v22.0
    CMU.CPVI.x32 i10 v23.0
    VAU.ADD.i8 v15 v21 v20
        || SAU.ADD.i8 i10 i10 i9
    NOP
    CMU.CPIV.x32 v23.0 i10
        || LSU1.ST64.1 v15 i18
```

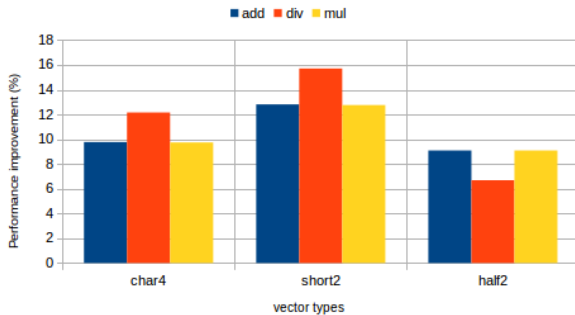

Thank you for your attention!

Questions ?

Contact: e.diken@tue.nl

LinkedIn: nl.linkedin.com/in/erkandiken/

TU/e Technische Universiteit
Eindhoven
University of Technology



Movidius 

HiPEAC

LLVM
COMPILER INFRASTRUCTURE